

**EQUIPO DE PARTIDA**

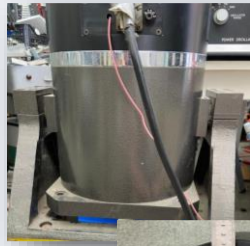

**Shaker electrodinámico**

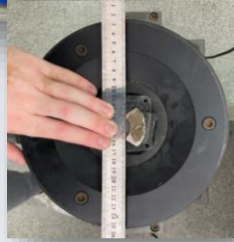

**DISEÑOS Y PROPUESTAS**

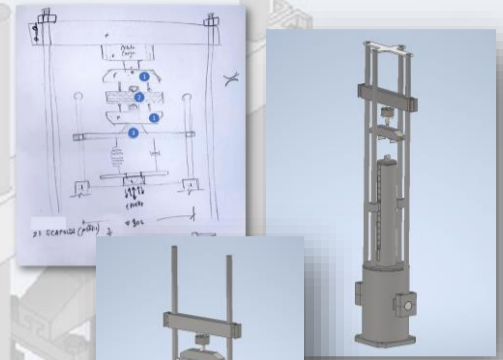

**COMPONENTES BIOMECÁNICOS CRÍTICOS A FATIGA**

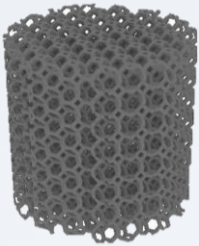

**Scaffolds para prótesis**



**Rotura por fatiga**

**PLANOS**

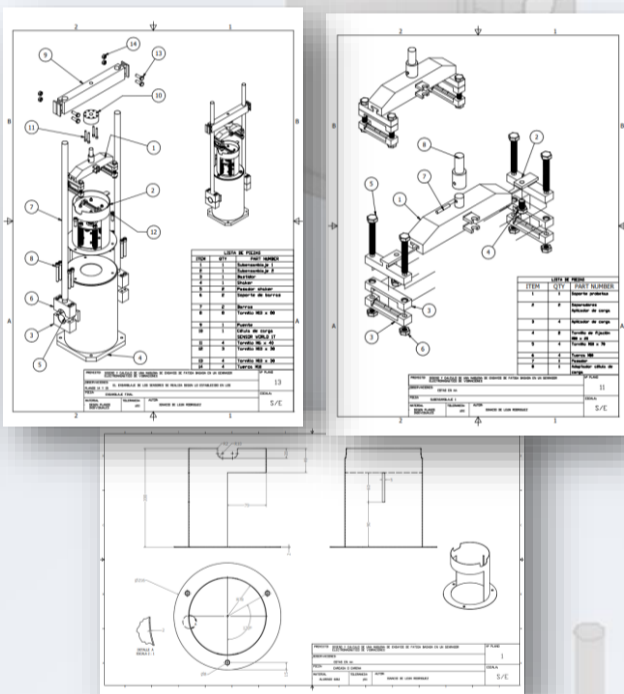

**DESARROLLO Y CÁLCULO DEL SISTEMA AMORTIGUADO RESULTANTE**

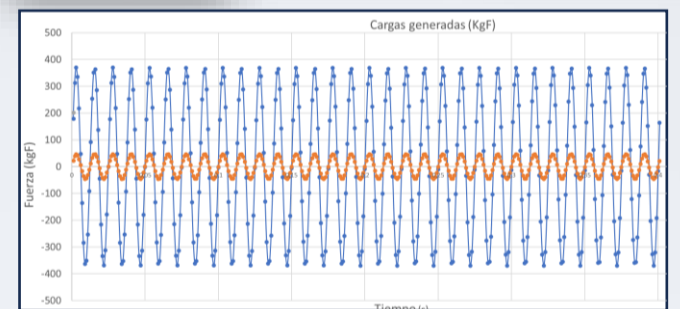
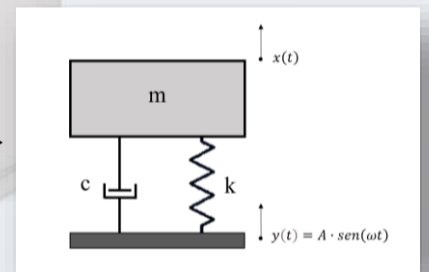
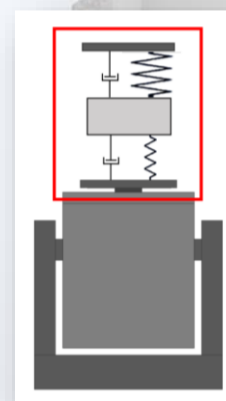

**DISEÑO DE UN SISTEMA DE MEDIDA Y ADQUISICIÓN DE DATOS**

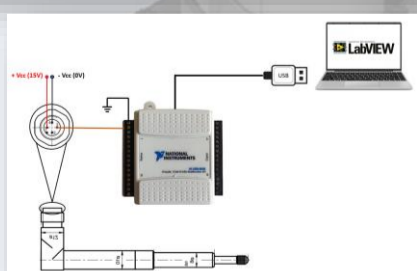

**VERIFICACIÓN DE COMPONENTES**

